

clinton

e l e c t r o n i c s



NVD

NETWORK VIDEO DECODERS

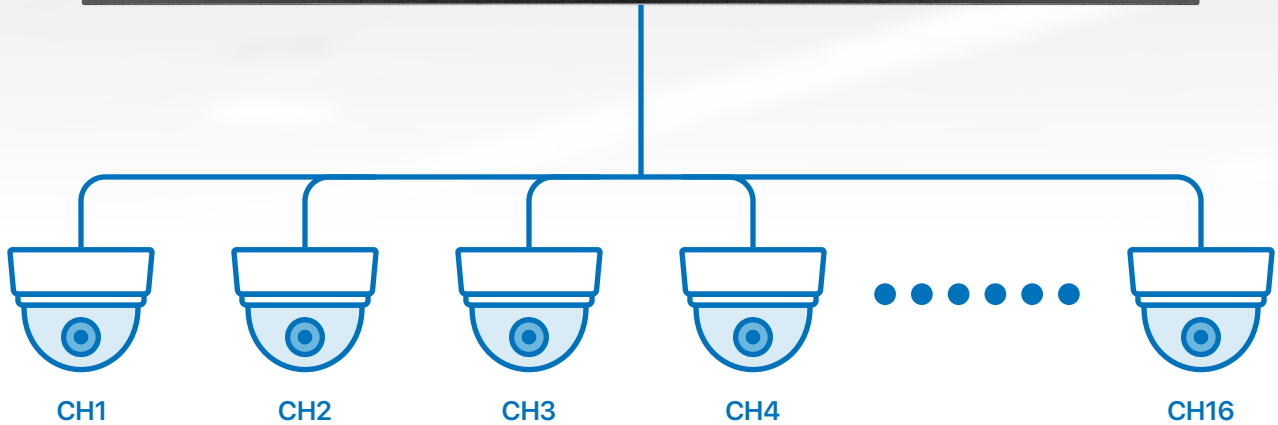

IP Video Decoders for Flexible, Real-Time Monitoring

Clinton IP video decoders provide a simple, cost-effective way to display live camera feeds without a PC or VMS. Available as a standalone decoder or as integrated decoder monitors in 22", 27", 32", and 43" sizes, they offer flexible deployment for virtually any environment.

Ideal for public view displays, loss prevention offices, drive-thru monitoring, and more, these solutions support multiview and sequence modes for real-time visibility. With plug-and-play setup, PoE or DC power options, and broad IP camera compatibility, Clinton decoders deliver reliable, scalable video display for modern retail and commercial environments.



NETWORK VIDEO DECODERS

Real-Time Performance

Engineered for high-performance, real-time video monitoring, these decoders are optimized to minimize black screen transitions and eliminate lag. The result is smooth, reliable live viewing—ideal for retail environments, loss prevention offices, warehouses, and other security-critical applications.



Camera Sequencing

Each layout can be configured to automatically sequence between cameras with adjustable duration settings. Cycle through multiple views to maintain consistent visibility across entrances, checkout areas, stockrooms, and other high-priority zones.

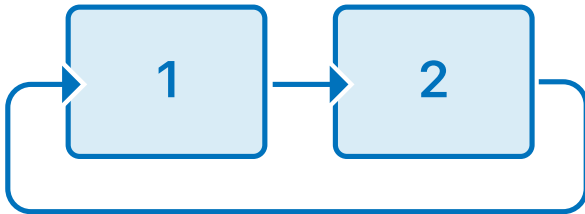

Flexible Multi-View Layouts

Select the layout that fits your environment. From single-camera views and quad layouts to 25 customizable configurations, on-screen video can be tailored to match specific monitoring priorities and operational workflows.

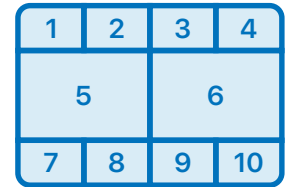
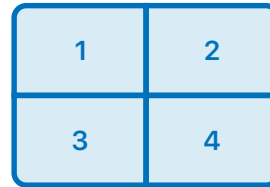

Broad IP Camera Compatibility

Supporting video streams up to 4K at 30 fps, the decoder integrates seamlessly with modern IP camera technologies. Compatible with H.265 and H.264 codecs, as well as panoramic, fisheye, and corridor-mode camera formats.

Remote Image Banners

Remotely load and display custom image banners directly on the screen. Reinforce security messaging, promote store policies, or boost brand awareness while maintaining live video—creating a stronger visual deterrent and enhanced customer awareness.

H.264
MPEG-4/AVC

H.265
HEVC

RECORDING IN PROGRESS

NOTICE VIDEO MONITORING IN PROGRESS

STORE LOGO®



CE-NVD16 – IP Video Decoder

CE-NVD16 – IP Video Decoder

The CE-NVD16 is a powerful 16-channel IP Video Decoder that turns virtually any HDMI display into a real-time monitoring station. Ideal for retail stores, loss prevention offices, warehouses, and public view applications, it delivers smooth 4K video at 30 fps from up to 16 IP cameras.

Choose from 25 layout options, including multiview and sequence modes, to match your needs. The CE-NVD16 supports up to 4K at 30 fps and integrates seamlessly with modern IP cameras. Compatible with H.265 and H.264 codecs, as well as panoramic, fisheye, and corridor-mode camera formats. With PoE or 12V DC power, NDAA/TAA compliance, and a rugged, mountable design, it offers flexible deployment in virtually any environment.

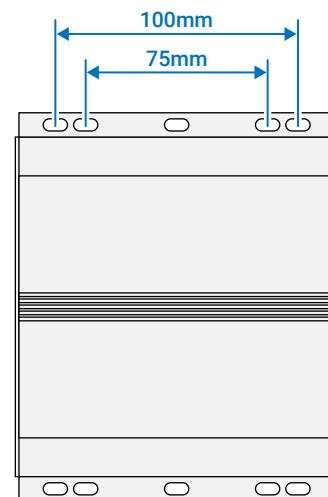



CE-NVD16

16 CH IP VIDEO DECODER

- Decodes up to 16 IP camera streams
- HDMI (4K) and VGA video outputs
- Multiview and sequence display modes with up to 25 custom layouts
- Supports camera streams up to 4K @ 30 fps
- Supports H.265, H.264, and MJPEG codecs
- Web-based management interface
- PoE or 12V DC power (power supply included)
- NDAA and TAA compliant

LAYOUT EXAMPLES

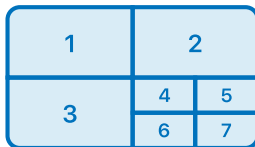
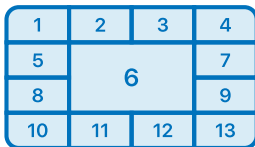
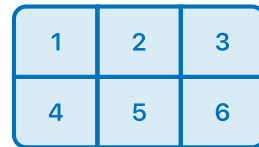
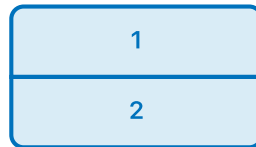
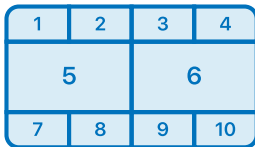
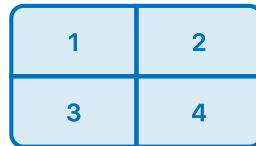
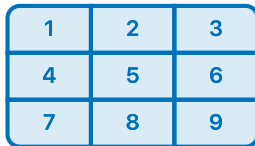
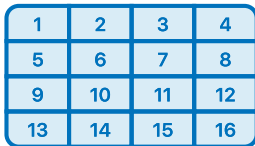



22" & 27" Decoder Monitors

CE-VT215-NVD – 22" Decoder Monitor

Compact and space-efficient, the 22" size is ideal for drive-thru windows, POS stations, pharmacy counters, and small back offices. Its smaller footprint makes it perfect for spot monitoring and secondary displays where space is limited but clear multi-camera visibility is still required.

CE-VT270-NVD – 27" Decoder Monitor

Offering the right balance of size and visibility, the 27" size is well-suited for loss prevention offices, self-checkout monitoring, C-stores, and manager desks. It delivers comfortable multi-camera viewing with improved readability at a distance while maintaining a clean, space-conscious footprint.

RECOMMENDED FOR



Drive Thru Lane Monitoring



Self Checkout Attendant Kiosk



Pharmacy Counters



Receiving Doors



Cash Counting Areas



C-Store Monitoring

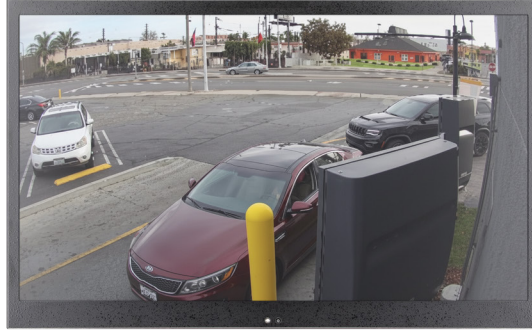

CE-VT215-NVD

22" IP VIDEO DECODER MONITOR

- Built-in 16-channel IP video decoder
- Multiview and sequence display modes with up to 25 custom layouts
- Supports camera streams up to 4K @ 30 fps
- Supports H.265, H.264, and MJPEG codecs
- Web-based management interface
- 1920 × 1080 resolution / 250 nit brightness / 1000:1 contrast ratio
- Configurable colored screen border highlight
- Selectable flashing LED indicator
- Slim black metal cabinet w/ VESA 100 (M4)
- PoE++ or 24V DC power (power supply sold separately)

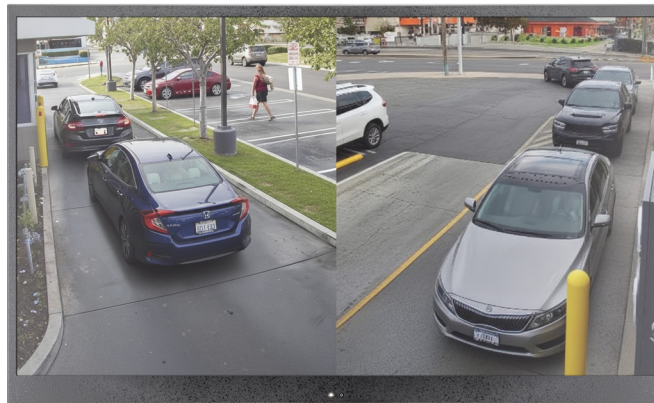

CE-VT270-NVD

27" IP VIDEO DECODER MONITOR

- Built-in 16-channel IP video decoder
- Multiview and sequence display modes with up to 25 custom layouts
- Supports camera streams up to 4K @ 30 fps
- Supports H.265, H.264, and MJPEG codecs
- Web-based management interface
- 1920 × 1080 resolution / 300 nit brightness / 3000:1 contrast ratio
- Configurable colored screen border highlight
- Selectable flashing LED indicator
- Slim black metal cabinet w/ VESA 100 (M4)
- PoE++ or 24V DC power (power supply sold separately)



32" & 43" Decoder Monitors

CE-VT320-NVD – 32" Decoder Monitor

A versatile, go-to size for retail environments, the 32" size is ideal for public view applications, large self-checkout zones, and stockroom or receiving areas. Its expanded screen space supports larger camera grids, making it well-suited for front-of-store deterrence and multi-camera monitoring.

CE-VT430-NVD – 43" Decoder Monitor

Designed for high-visibility monitoring, the 43" size excels on open retail floors, central security desks, and warehouse or distribution environments. The larger display enhances situational awareness and allows operators to monitor multiple camera streams from greater distances.

RECOMMENDED FOR



C-Store
Monitoring



Store
Entrances



Self Checkout
Attendant Kiosk



Distribution
Centers



Loss Prevention
Offices



Receiving
Doors



CE-VT320-NVD

32" IP VIDEO DECODER MONITOR

- Built-in 16-channel IP video decoder
- Multiview and sequence display modes with up to 25 custom layouts
- Supports camera streams up to 4K @ 30 fps
- Supports H.265, H.264, and MJPEG codecs
- Web-based management interface
- 1920 × 1080 resolution / 350 nit brightness / 3000:1 contrast ratio
- Configurable colored screen border highlight
- Selectable flashing LED indicator
- Slim black metal cabinet w/ VESA 100 (M4)
- PoE++ or 24V DC power (power supply sold separately)

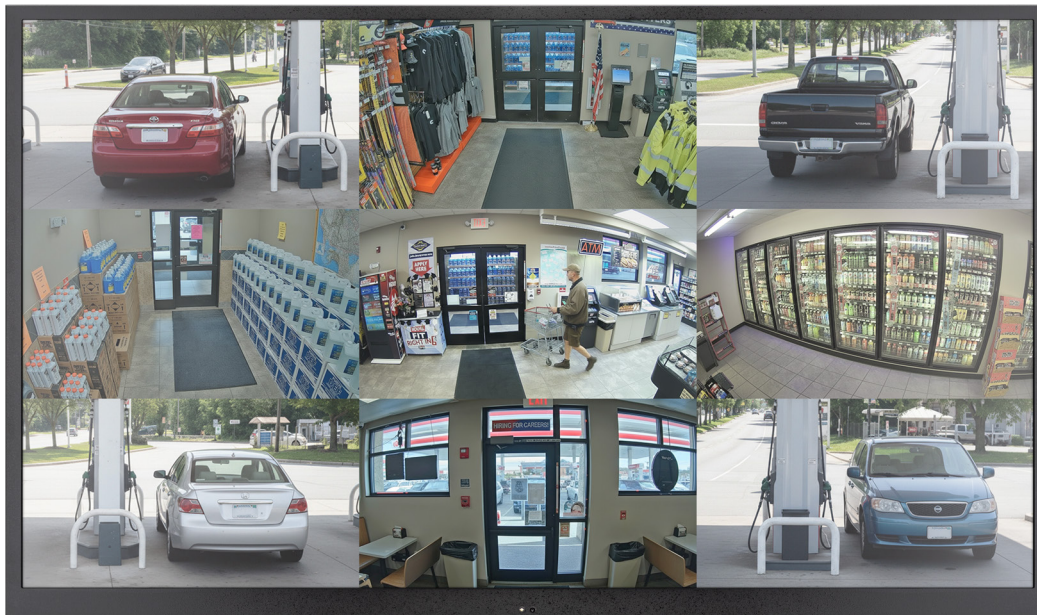

CE-VT430-NVD

43" IP VIDEO DECODER MONITOR

- Built-in 16-channel IP video decoder
- Multiview and sequence display modes with up to 25 custom layouts
- Supports camera streams up to 4K @ 30 fps
- Supports H.265, H.264, and MJPEG codecs
- Web-based management interface
- 1920 × 1080 resolution / 250 nit brightness / 1000:1 contrast ratio
- Selectable flashing LED indicator
- Slim black metal cabinet w/ VESA 100 (M4) & 200 (M6)
- PoE++ or 24V DC power (power supply sold separately)



PoE++ Power Injector

CE-PS400POE – 4 Port PoE++ Injector

The CE-PS400POE delivers true PoE++ power—rarely available in standard switches or injectors. With four PoE++ output ports providing up to 90 watts per port and 360 watts total output, it can power up to four 43" decoder monitors, public view monitors, or other high-demand IP devices from a single unit.

Fully IEEE 802.3bt compliant, it integrates easily into modern PoE++ systems. Built-in protection safeguards connected devices, and the compact 1U design allows for simple rack or truss mounting. It's a clean, efficient power solution for retail and security deployments.

RECOMMENDED FOR



Decoder Monitors



Public View Monitors



Network Cameras



PoE Lighting



Access Control Readers

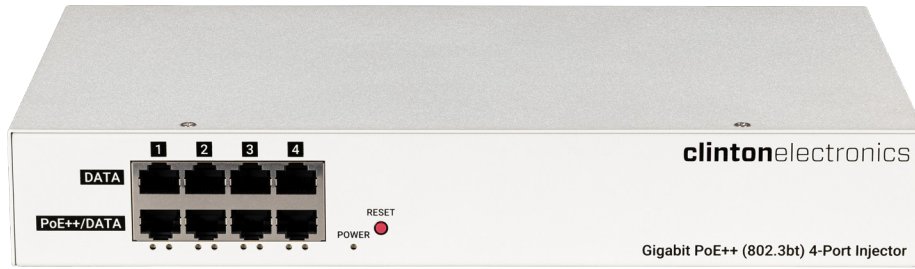

CE-PS400POE

4 PORT PoE++ INJECTOR

- 4 × RJ-45 data input ports
- 4 × RJ-45 PoE++ output ports (data and power)
- IEEE 802.3bt compliant
- Up to 90W per port
- 360W total power output
- Output ports feature current limiting and short-circuit protection
- Converts 100–240V AC input to low-voltage DC output
- Smart plug-and-play operation
- 19" rack-mountable (1U) with optional truss mount
- Includes AC power cord and rack-mount brackets

CONNECTION DIAGRAM

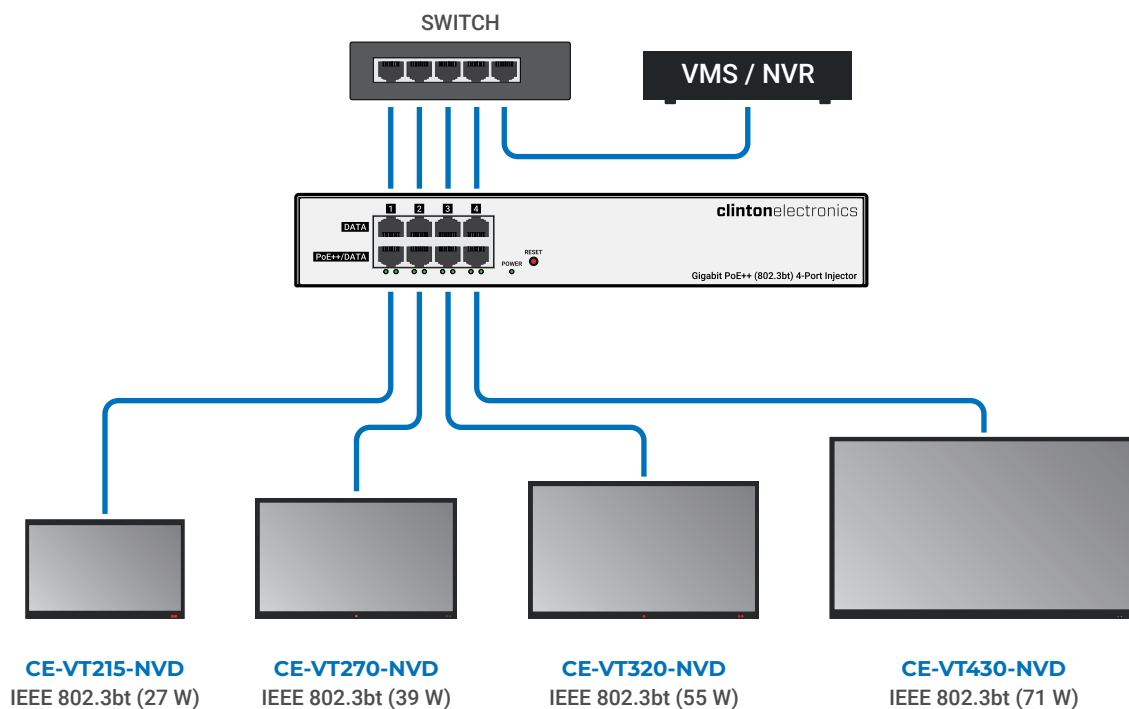

clintonelectronics

At Clinton Electronics, we combine over six decades of experience with a commitment to quality, customer service, and innovation. As a family-owned business, we take pride in offering personalized support, a vast selection of products, and a dedication to building long-lasting relationships with our partners. Our knowledgeable team, extensive resources, and focus on reliability set us apart, ensuring you get the right solutions when you need them.

Family Owned

Since 1963, Clinton Electronics has built a legacy of trust, quality, and customer commitment. Our family values, passed down through generations, ensure every product and service reflects our dedication and care.

Dedicated Sales Team

Our inside sales team offers personalized support to meet your needs. From system design and custom quotes to product recommendations, our experts are here to provide the right solutions for you.

3-Year Warranty

We stand behind the quality of every product we sell with a comprehensive three-year warranty, including advance replacement during the first year to ensure minimal downtime.

Extensive Selection

No matter the application or job size, we offer a wide range of products to meet your needs. With a vast inventory on hand, we ensure you have access to the right products, exactly when you need them.

Free Technical Support

Our US-based technical support team is ready to assist with installation questions, troubleshooting, or warranty requests. For help, visit support.clintonelectronics.com or call 800-549-6393 (Monday-Friday).

Protected Pricing

Clinton Electronics does not sell directly to end-users or publicly advertise pricing. Our protected dealer pricing ensures that only authorized dealers and integrators can access exclusive pricing information.



Scan QR Code



To Learn More